

***XL***logic

**E Signature™ Channel  
Owner's Manual**



# Solid State Logic



Super-Analogue™ Outboard

Owner's Manual

## Solid State Logic

Begbroke, Oxford, England, OX5 1RU • +44 (0)1865 842300

320 West 46th Street, 2nd Floor, New York, NY 10036, USA • +1 (1) 212 315 1111  
Suite 401, 5757 Wilshire Blvd, Los Angeles, CA 90036, USA • +1 (1) 323 549 9090  
3-55-14 Sendagaya, Shibuya-Ku, Tokyo 151-0051, Japan • +81 (0)3 5474 1144  
7 bis, rue de la Victoire, le Blanc Mesnil, Paris 93150, France • +33 (0)1 48 67 84 85  
Via Timavo 34, 20124 Milano, Italy • +39 (0)39 2328 094

Visit SSL at URL: <http://www.solid-state-logic.com>

© Solid State Logic

All Rights reserved under International and Pan-American Copyright Conventions

E Series, E Signature, SL 4000 E Series, SL 9000 Series, Solid State Logic, SSL, XL 9000 Series  
and XLogic are trademarks of Solid State Logic

All other product names and trademarks are the property of their respective owners

No part of this publication may be reproduced in any form or  
by any means, whether mechanical or electronic, without the  
written permission of Solid State Logic, Oxford, England

Initial Release (Rev. 0A), November 2005

As research and development is a continual process, Solid State Logic reserves the right  
to change the features and specifications described herein without notice or obligation

E&OE

---

---

## Contents

1.0	Introduction	3
2.0	Safety Considerations	4
	Safety Warnings	4
3.0	Installation	6
	Setting the mains voltage selector	6
	Mounting	7
	Connections	7
4.0	Operation	9
	Input Section	9
	Listen Mic Compressor	9
	Dynamics Section	10
	Compressor/Limiter	10
	Expander/Gate	11
	Filter Section	11
	Equaliser Section	12
	Output Section	12
5.0	Signal Routing	13
Appendices:		
A	Internal Links and Fuses	15
B	Connector Details	16
C	Electronic Specification	17
D	Calibration Information	21
E	Physical Specification	24
F	Environmental Specification	24

XLogic E Signature™ Channel (front)

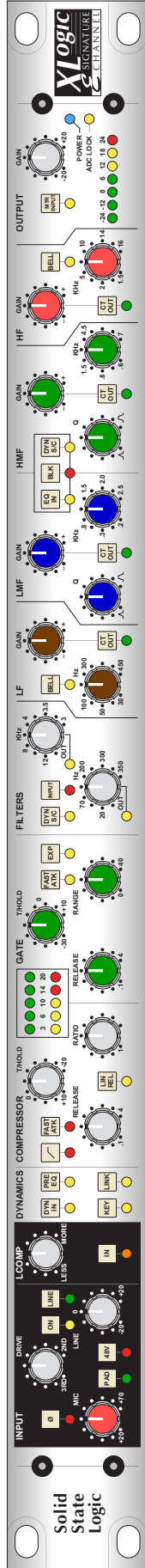

XLogic E Signature™ Channel (rear)

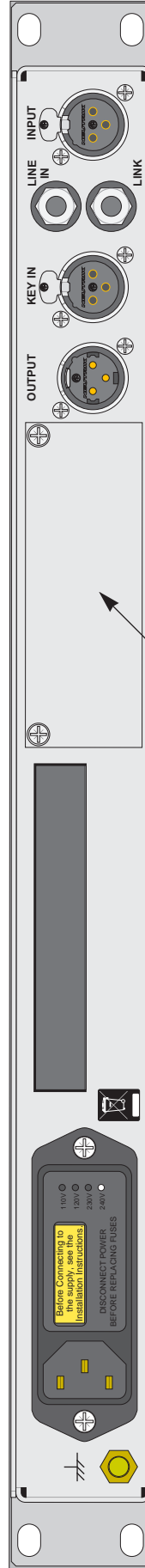

Blanking plate for (optional) ADC card

## **1.0 Introduction**

The XLogic E Signature Channel unit brings the classic sound of the original early 1980s E Series console to the outboard rack of today's artists and producers. The XLogic E Signature Channel delivers the choice of selectable transformer driven or Variable Harmonic Drive (VHD) mic amps and the world renowned 'Listen Mic' compressor – the secret weapon of many producers of the era – along with two distinctive Equaliser options coupled with the most musical dynamics processor available in either analogue or digital domain.

An optional ADC card is available (SSL part number: 629945XT) to provide an additional digital audio output.

The object of this manual is to provide purchasers of the XLogic E Signature Channel unit with information in the following areas:

- Safety considerations
- Installation requirement
- Electrical connections and cabling
- Connector pin outs
- Specifications and physical dimensions

### **Warranty**

The warranty period for this unit is 12 months from date of purchase.

### **In Warranty Repairs**

In the event of a fault during the warranty period the unit must be returned to your local distributor who will arrange for it to be shipped to Solid State Logic for repair. All units should be shipped to Solid State Logic in their original packaging. Solid State Logic can not be held responsible for any damage caused by shipping units in other packaging. In such cases Solid State Logic will return the unit in a suitable box, which you will be charged for. Please do not send manuals, power leads or any other cables - Solid State Logic can not guarantee to return them to you. Please also note that warranty returns will only be accepted as such if accompanied by a copy of the receipt or other proof of purchase.

### **Out of Warranty Repairs**

In the event of a fault after the warranty period has expired, return the unit in its original packaging to your local distributor for shipment to Solid State Logic. You will be charged for the time spent on the repair (at Solid State Logic's current repair rate) plus the cost of parts and shipping.

## 2.0 Safety considerations

This section contains definitions and warnings, and practical information to ensure a safe working environment. Please take time to read this section before undertaking any installation work.

### 2.1 Definitions

#### *'Maintenance'*

All maintenance must be carried out by fully trained personnel. *Note: it is advisable to observe suitable ESD precautions when maintenance to any part is undertaken.*

#### *'Non-User Adjustments'*

Adjustments or alterations to the equipment may affect the performance such that safety and/or international compliance standards may no longer be met. Any such adjustments must therefore only be carried out by fully trained personnel.

#### *'Users'*

This equipment is designed for use solely by engineers and competent operators skilled in the use of professional audio equipment.

#### *'Environment'*

This product is a Class A product intended to form an integrated component part of a professional audio recording, mixing, dubbing, film, TV, radio broadcast or similar studio wherein it will perform to specification providing that it is installed according to professional practice.

### 2.2 Electrical Safety Warning

When installing or servicing any item of Solid State Logic equipment with power applied, when cover panels are removed, HAZARDOUS CONDITIONS CAN EXIST.

These hazards include:

- High voltages
- High energy stored in capacitors
- High currents available from DC power busses
- Hot component surfaces

Any metal jewellery (watches, bracelets, neck-chains and rings) that could inadvertently come into contact with uninsulated parts should always be removed before reaching inside powered equipment.

### 2.3 Installation

#### **Voltage Selection and Fusing**

All XLogic units have selectable voltage inlets. Always confirm that the input mains voltage range is set correctly before applying power. Always isolate the mains supply before changing the input range setting.

If it is ever necessary to replace a blown mains-fuse, then always use the correct rating and type of replacement. If a correctly rated fuse continues to blow, then a fault exists and the cause should be investigated or the unit returned to Solid State Logic for repair/replacement as appropriate.

Details of mains settings and correct fuse ratings can be found in Section 3.1 and Appendix A of this manual.

#### **Safety Earth Connection**

Any mains powered item of Solid State Logic equipment that is supplied with a 3-core mains lead (whether connectorised or not) should always have the earth wire connected to the mains supply ground. This is the safety earth and grounds the exposed metal parts of the racks and cases and should not be removed for any reason.

### Mains Supply and Phases

Solid State Logic equipment is designed for connection to a single phase supply with the Neutral conductor at earth potential – category TN – and is fitted with a protective fuse in the Live conductor only. It is not designed for use with Phase (Live) and Neutral connections reversed or where the Neutral conductor is not at earth potential (TT or IT supplies).

Mains cables will be coded with the following colour scheme:

LIVE:	Brown
NEUTRAL:	Blue
EARTH:	Yellow/Green

### Mains Isolation and Over-Current Protection

An external disconnect device is required for this equipment; a detachable power cord, as fitted to this equipment, is a suitable disconnect device. Note that the socket outlet used for the detachable power cord should be installed near the equipment and should be easily accessible.

An external over-current protection device is required to protect the wiring to this equipment which must be installed according to current wiring regulations. The fusing or breaking-current is defined in the environmental specification in the appendix of this manual. In certain countries this function is supplied by use of a fused plug.

### CE Certification



Note that the majority of cables supplied with Solid State Logic equipment are fitted with ferrite rings at each end. This is to comply with current European CE regulations and these ferrites should not be removed.

If any of the unit metalwork is modified in any way the CE certification status of the product may be adversely affected.

### FCC Certification

The XLogic unit has been tested and found to comply with the limits for a Class A digital device, pursuant to part 15 of the FCC Rules. These limits are designed to provide reasonable protection against harmful interference when the equipment is operated in a commercial environment. This equipment generates, uses, and can radiate radio frequency energy and, if not installed and used in accordance with the instruction manual, may cause harmful interference to radio communications. Operation of this equipment in a residential area is likely to cause harmful interference in which case the user will be required to correct the interference at his own expense.

### Instructions for Disposal of WEEE by Users in the European Union



The symbol shown here is on the product or on its packaging, which indicates that this product must not be disposed of with other waste. Instead, it is the user's responsibility to dispose of their waste equipment by handing it over to a designated collection point for recycling of waste electrical and electronic equipment. The separate collection and recycling of your waste equipment at the time of disposal will help to conserve natural resources and ensure that it is recycled in a manner that protects human health and the environment. For more information about where you can drop off your waste equipment for recycling, please contact your local city office, your household waste disposal service or where you purchased the product.

## 2.4 Graphical Symbols

The following symbols may be used either on the product or in this manual:



General hazard – refer to user or service manual for details.



Electrical hazard.



Protective Earth (ground).



Frame or Chassis terminal.

### 3.0 Installation

#### 3.1 Voltage Selection

Before connecting the mains supply ensure that the voltage range selector next to the IEC socket on the rear of the unit is correctly set. The input setting must be confirmed before applying power. The input module can be configured to be one of 4 voltage settings (*one of which is invalid and should not be used – see below*). The setting is indicated by a plastic pin protruding through the appropriate hole in the fuse panel.

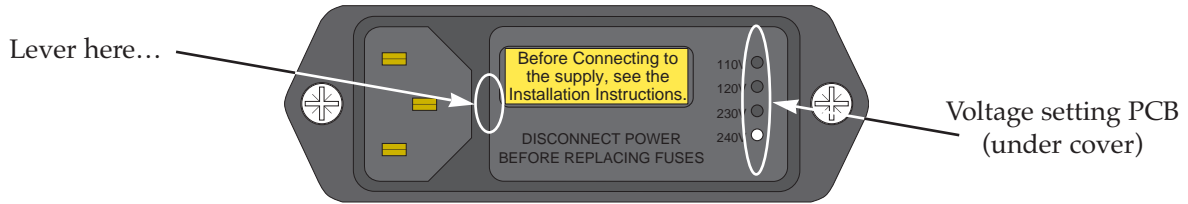

Mains Inlet Module (set for '240V')

The setting is altered by a small vertical PCB which can be fitted in 4 positions.

To change the setting:

Switch off and remove the IEC lead.

Using a small flat-bladed screwdriver, lever open the fuse panel to the right of the connector.

At the right hand side is a vertical PCB with a plastic key which indicates the setting. Using pliers, pull out the PCB.

The PCB has to be rotated until the desired voltage is shown along the edge which plugs into the module. The plastic key (and this bit is quite fiddly) must also be rotated so that it points out of the module and so that the round pin aligns with the appropriate hole in the cover panel; (refer to the diagrams opposite).

Re-insert the PCB and replace the fuse panel. The plastic pin should project through the appropriate hole.

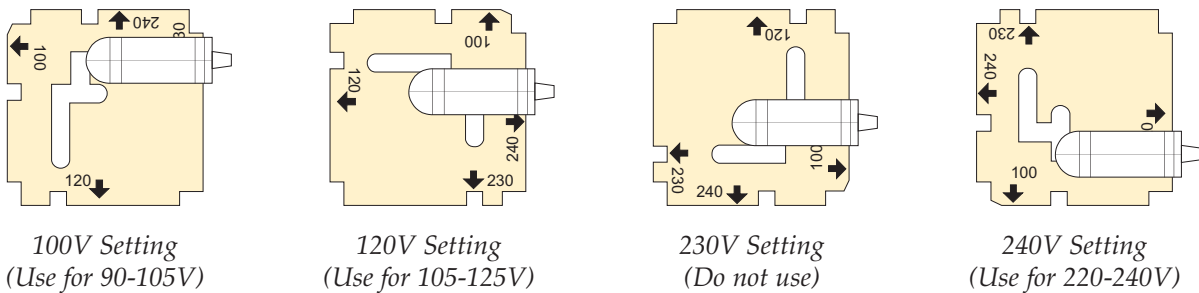

Mains Inlet Voltage Setting PCB

*These diagrams show the PCB arrangements for the different voltage settings.*

*Note that where the mains voltage is a nominal 230V, the '240V Setting' should be used – not the '230V Setting'!*

### 3.2 Mounting

This unit is designed to be rack-mounted. It is 1 RU (44.5mm/1.75 inch) high, its depth is:

325 mm/12.8 inches not including heatsink.

365 mm/14.3 inches including heatsink

400 mm/15.75 inches including connectors

The XLogic E Signature Channel units incorporate reinforcement brackets into the chassis and so are suitable for direct rack-mounting. A 1RU space should be left above each unit to ensure adequate ventilation.

### 3.3 Connection

There are five connectors on the rear panel:

- OUTPUT (male XLR)
- KEY IN (female XLR)
- LINE IN (TRS jack socket)
- LINK (TRS jack socket)
- INPUT (female XLR)

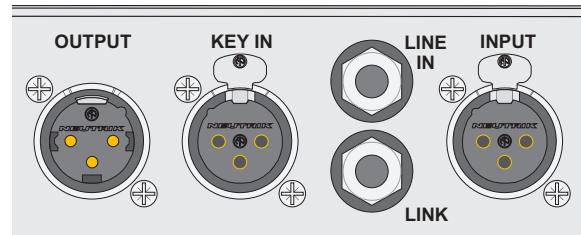

The XLR labelled 'INPUT' is for microphone signals; the 'LINE IN' jack socket is for line level signals such as a synthesiser or DAW output. Neither input is suitable for use with guitar pickups, piezo electric bugs etc.

If you have more than one unit, the dynamics side-chain of multiple units may be linked together by connecting the 'LINK' jacks together using a mono or stereo jack-to-jack cable(s).

The 'KEY IN' XLR provides line level access to the dynamics side-chain to enable the dynamics to be keyed from external sources.

The XLR labelled 'OUTPUT' is a line level output; connect this to your recorder, workstation or mixing desk.

# XLogic E Signature™ Channel Block Diagram

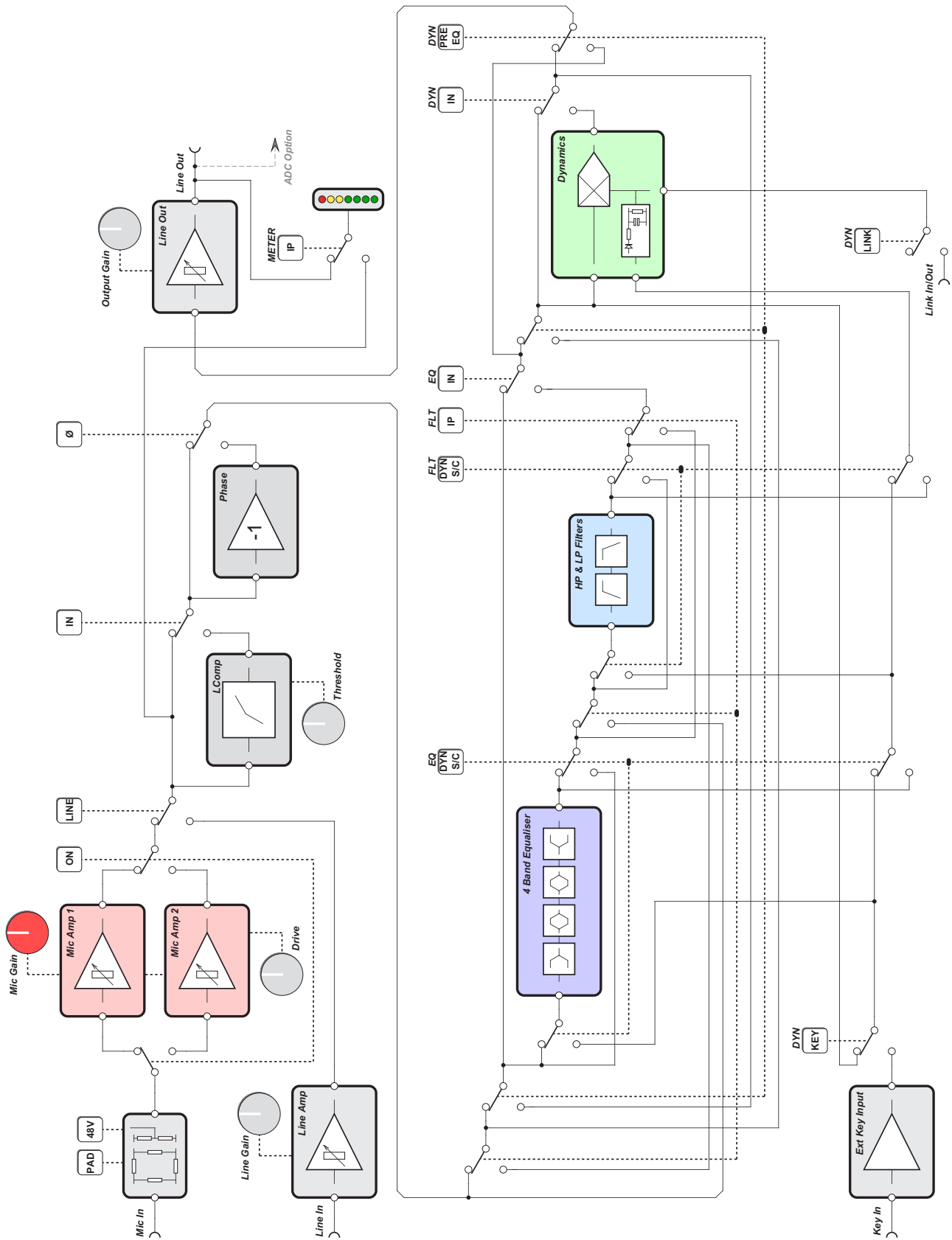

## 4.0 Operation

The XLogic E Signature Channel unit is a 1U rack mounting unit containing a complete set of signal processing based upon the SL 4000 E Series channel strip – Input, Compressor/Limiter, Expander/Gate, Hi and Lo pass Filters and Equaliser.

The signal processing order can be changed and the EQ and Filter sections used in the Dynamics side chain, providing a wide range of signal processing options.

Obviously there are many different permutations of signal routing, allowing an enormous number of creative possibilities. This section looks at each control on the XLogic E Signature Channel individually, working from left to right, with a brief summary of the routing possibilities. See Section 5 for more on routing.

### 4.1 Input Section

The Input section contains two completely independent Mic amps together with an electronically balanced Line input with its own gain control. The primary Mic amp is a classic transformer coupled design using the same Jensen component as the original E Series channel strips. The second option is engaged via the **ON** switch. This replaces the original preamp with a new electronically balanced design with SSL's unique variable harmonic drive circuitry. This unique preamp emulates the overload characteristics of a traditional valve/tube design but with the ability to tailor the warmth or musicality via the **DRIVE** control. This shapes the overload curve to provide a user controlled blend of 2nd or 3rd harmonic distortion.

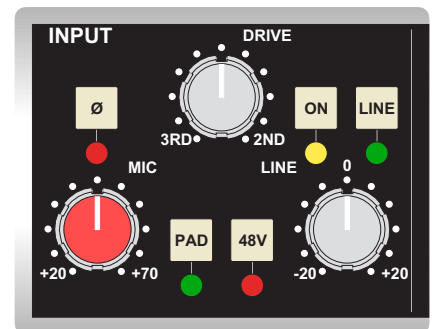

Both of these preamps use the same gain control providing +20dB to +70dB gain and share a passive front end with a switchable 22dB Input Pad and +48V phantom powering.

*Please note that connecting a microphone to the XLogic E Signature Channel unit with phantom power switched on is not advised as it may cause damage to either the microphone or the input stage of the XLogic unit. Take care not to connect line level sources (keyboards etc.) to the microphone input with phantom power switched on as this may damage the output stage of the connected unit.*

A **Ø (Phase)** switch is provided to reverse the phase of the selected channel input.

### 4.2 Listen Mic Compressor



The SSL 'Listen Mic' Compressor was, throughout the 1980's, the secret weapon in many producers sonic arsenal of recording techniques. Originally designed to prevent overloading the return feed from a studio communications mic, its fixed attack and release curves were eminently suitable for use on ambient drums mics. The console surgery required to gain access to the compressed output was performed on many early E Series consoles before it became a standard modification on latter production systems. The original circuit has been added into the XLogic E Signature Channel unit, enhanced with the addition of a front panel threshold adjustment and a simple traffic light indication of gain reduction. Due to the vagaries of the original design, the range of the threshold control is indicated as either **LESS** or **MORE**! The gain reduction indication takes the form of a bi-colour LED located under the **IN** switch; it will glow green to show that it is in-circuit and then progressively redder as more compression

is applied. The circuit follows directly after the input stage allowing either microphone or line level signals to benefit from the sonic possibilities provided by this compressor.

### 4.3 Dynamics Section

The Dynamics section of the XLogic E Signature Channel unit comprises a compressor/limiter and an expander/gate, both of which use the same gain change element. The design returns faithfully to the circuit and key components which defined the sound of the original E Series channel strip. A true RMS converter is used in the side chain whilst the gain element is an all discrete design identical to the Class A VCA chip used in the original unit. The compressor contains additional switching options to defeat the over-easy curve and to use a linear release instead of the more usual logarithmic curve. The result is a compressor with three distinct voicings, all of which contributed to the many classic records tracked and mixed on early E Series consoles.

As in the original E Series channel strip, the Filter and/or the Equaliser section can be assigned to the dynamics side chain allowing de-essing etc.

The Dynamics section has some master function buttons associated with it. Section 5 deals with Dynamics routing in more detail, but briefly these buttons function as follows:

**DYN IN** – Switches the Dynamics section into the signal path, post the EQ.

**PRE EQ** – Places the Dynamics section pre the EQ section (but post the Filter section if the Filter INPUT switch is pressed).

**KEY** – Switches the Dynamics side chain to the 'KEY' input on the rear panel of the unit.

If you have more than one unit and have connected the 'LINK' jacks on the rear of the units together, the side chain control signals of multiple units can be linked by pressing the **LINK** switch on those units you wish to gang. When two Dynamics sections are linked, the control voltages of each section sum together, so that whichever section has the most gain reduction will control the other section.

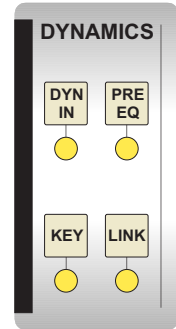

*Don't try to link two gates using the **LINK** switch when you want the signal on one to open the other. If you need to achieve this effect, take a keying signal from one section to trigger the other. The easiest way to do this is by patching from the output of the 'source' channel into the 'KEY' input of the 'destination' channel, and selecting **KEY** (see above) on this channel.*

### 4.4 Compressor/Limiter

**RATIO** – When turned to 1:1, the Compressor/Limiter section is inactive. Turning the control clockwise increases the compression ratio to give a true limiter at the fully clockwise position.

The compressor ordinarily has an 'over-easy' characteristic. Selecting  changes this to peak sensing, and replaces the 'over-easy' characteristic with a 'hard knee', providing an alternative for some instruments.

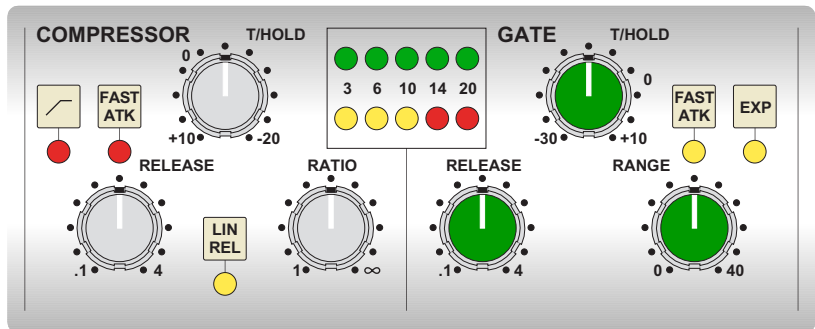

**THRESHOLD** – Whenever a signal exceeds the level set by this control, the compressor will start to act at the ratio set by the **RATIO** control. This control also provides automatic make-up gain, so as you lower the threshold and introduce more compression, the output level is increased, maintaining a steady output level regardless of the amount of compression.

**RELEASE** – Sets the time constant (speed) with which the compressor returns to normal gain settings once the signal has passed its maximum.

**FAST ATT** – Provides a faster attack time (3mS for 20dB gain reduction). When off the attack time is slower and less aggressive (30mS for 20dB gain reduction).

**LIN REL** – Changes the release curve from logarithmic to linear. This also raises the threshold by 6dB.

The yellow and red LEDs, on the bottom of the LED display area, indicate the amount of gain reduction (compression).

## 4.5 Expander/Gate

The Expander/Gate section can act either as a  $\infty$ :1 Gate or, when the **EXP** switch is pressed, as a 2:1 Expander.

**RANGE** – Determines the depth of gating or expansion. When turned fully anti-clockwise, the Expander/Gate section will be inactive. When turned fully clockwise, a range of 40dB can be obtained.

**THRESHOLD** – Variable hysteresis is incorporated in the threshold circuitry. For any given ‘open’ setting, the Expander/Gate will have a lower ‘close’ threshold. The hysteresis value is increased as the threshold is lowered. This is very useful in music recording as it allows instruments to decay below the open threshold before gating or expansion takes place.

**RELEASE** – This determines the time constant (speed), variable from 0.1 – 4 seconds, at which the Gate/Expander reduces the signal level once it has passed below the threshold. Note that this control interacts with the Range control.

**FAST ATT** – Provides a fast attack time (100 $\mu$ s per 40db). When off, a controlled linear attack time of 1.5ms per 40dB is selected. The attack time is the time taken for the Expander/Gate to ‘recover’ once the signal level is above the threshold. When gating signals with a steep rising edge, such as drums, a slow attack may effectively mask the initial ‘THWACK’, so you should be aware of this when selecting the appropriate attack time.

The green LEDs in the display section indicate Expander/Gate activity (the amount of gain reduction).

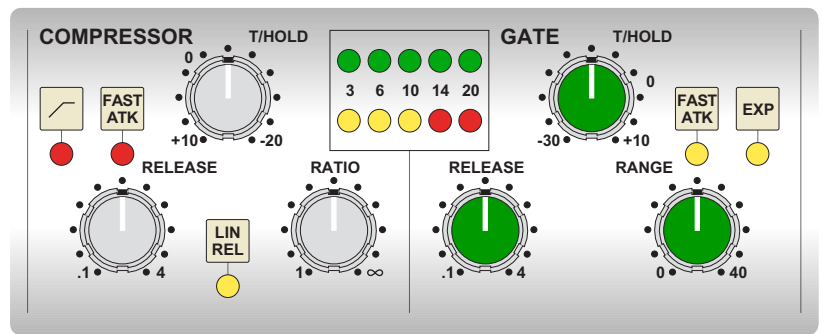

## 4.6 Filters Section

In common with the original E Series Channel strip, a pair of high- and low-pass Filters are provided. Both Filter controls incorporate bypass switching which is activated when turned fully anti-clockwise; turning either control up will put that band in circuit, illuminating the LED adjacent to the control to indicate this state. The Filters are normally placed post- the EQ but can be routed to different audio paths within the module. Both Filters normally exhibit a 12dB/octave but pressing the **BLK** switch in the EQ section will modify the slope of the high-pass Filter to 18dB/octave – see Section 4.7 overleaf for more detail on this switch. Section 5 describes the routing combinations in more detail but, briefly, these buttons function as described below.

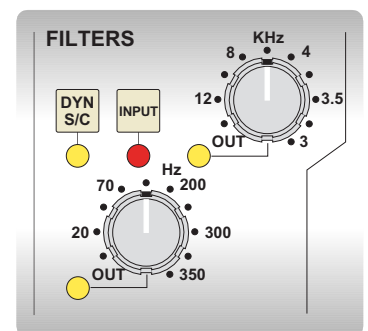

**DYN SC** – The Filters are switched into the sidechain of the Dynamics section. The Equaliser can be switched into the sidechain independently. Note that DYN SC overrides the INPUT function (see below).

**INPUT** – Moves the Filters to put them in circuit immediately post the Channel Input section. This allows the Filters to be used to clean up signals before compressing them. Selecting Dynamics ‘PRE EQ’ will allow the compressed signal to be EQ’d.

### 4.7 Equaliser Section

The XLogic E Signature Channel unit equaliser section defaults to the original 'Brown Knob' circuit that was standard on all early production E Series consoles. The two parametric mid-band sections feature SSL's classic logarithmically symmetric design that ensures that the  $\pm 3\text{dB}$  up/down points retain the same musical interval from the centre frequency regardless of frequency and amplitude settings. The two shelving sections are traditional 6dB/octave designs with an option for a fixed Q parametric response (Bell). The '02' EQ, to give it its correct name, was used on countless recordings and mixes in the early eighties. It is offered here incorporating a switchable version of a field modification that was carried out on a number of consoles – the **CT OUT** switch defeats the inherent non-interactive nature of the design and introduces subtle control interactions similar to those found on earlier parametric units. It also offers a different gain law with increased resolution in the critical initial boost or cut area. This function can be selected individually for each band.

In 1983 a new '242' EQ circuit was developed in conjunction with the legendary George Martin for the first SSL console to be installed in AIR studios. The 'Black Knob' EQ, as it became known, featured enhanced cut and boost ranges ( $\pm 18\text{dB}$  instead of  $\pm 15\text{dB}$ ) together with a different control law and a steeper 18dB/octave high pass filter for tighter control of low frequencies. It is this design which is retained today as the 'E Series' EQ option of the SL and XL 9000 Series consoles and the XLogic Channel unit. The design is enhanced in this version via the **CT OUT** option for additional tonal variations and is activated by pressing the **BLK** switch.

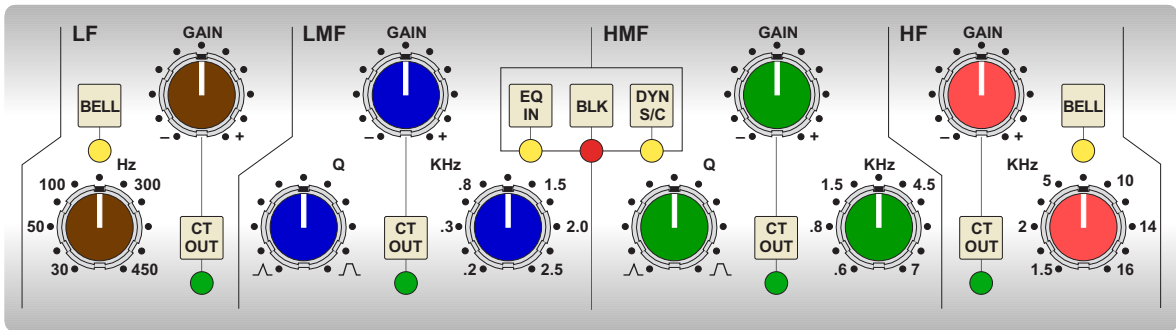

As mentioned above, the EQ section has some master function buttons associated with it:

**EQ IN** – Switches the EQ section into circuit.

**BLK** – Switches the EQ from 'Brown Knob' operation to 'Black Knob' operation – see above.

**DYN SC** – Switches the EQ section into the sidechain of the Dynamics section. The Filter section can be switched independently of the EQ section. If both Filter and EQ sections are assigned to the dynamic sidechain the Filter section precedes the EQ. Section 5 describes the routing combinations in more detail.

### 4.8 Output Section

The Output section consists of a centre indented,  $\pm 20\text{dB}$  output gain control and a 7-segment LED meter. Normally the meter reads the output of the channel, but selecting **MTR INPUT** will meter the signal immediately post the input section.

The blue **POWER** LED indicates that the unit is powered (what else?).

The **ADC LOCK** LED is a bi-colour LED which indicates that the (optional) ADC card is locked to an external clock. It will illuminate yellow to indicate external lock, red for internal lock.

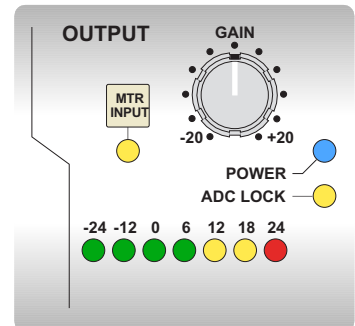

## 5.0 Signal Routing

### Channel Processing Order

There are two switches that control the order of the signal processing elements. These are Filters to **INPUT** and Dynamics **PRE EQ**. The table below shows the effect of these:

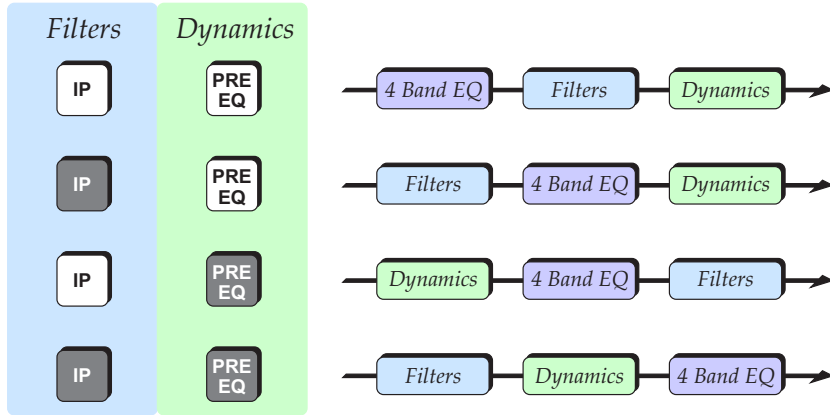

### Side Chain Processing Order

The EQ and Filter sections can be assigned to the dynamics side chain using the **DYN S/CH** switches in the respective sections. The table below shows the sidechain source and processing for the various combinations of these:

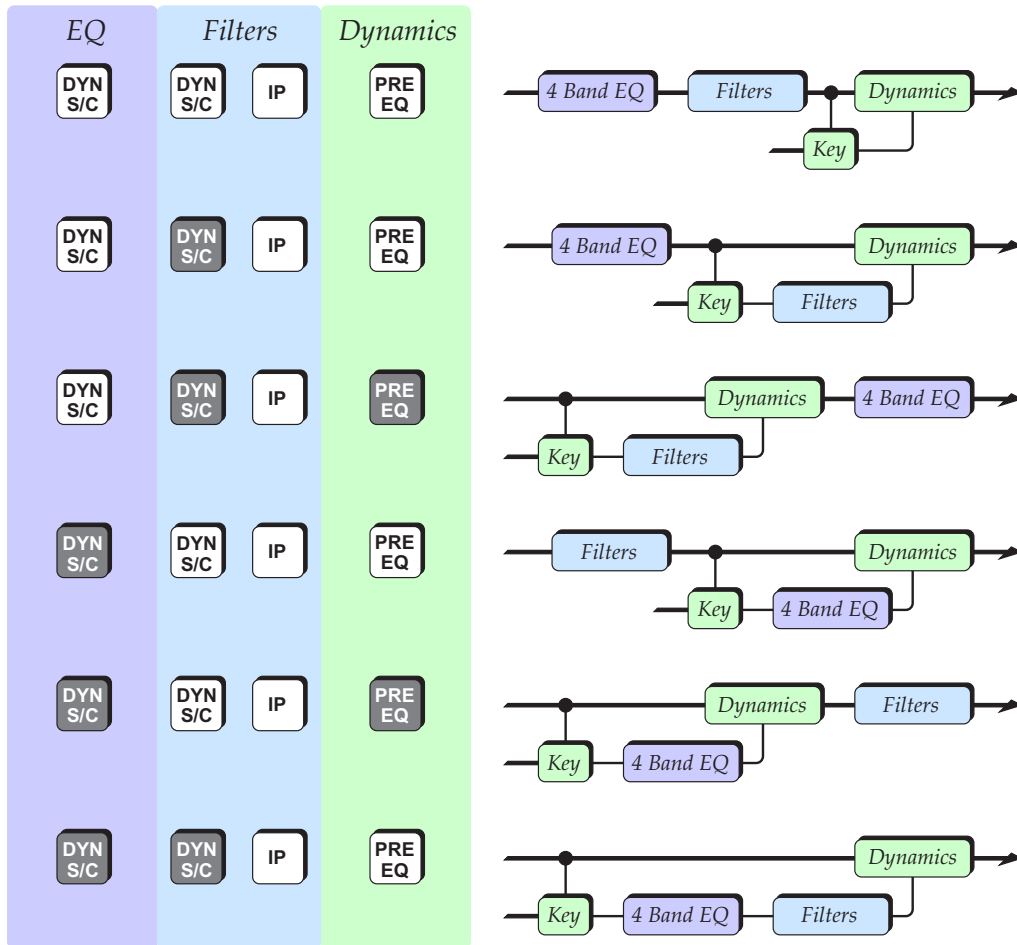

Note that the side chain can be fed from the **KEY** input on the rear of the unit by selecting **KEY**.

*Stop looking – we left this page blank...*

---

## Appendix A – Internal Links and Fuses

### Fuses (Mains Inlet)

The mains inlet contains a single 1 amp 1.25" time delay fuse (SSL Part No. 35FJJ310). To change it disconnect the mains inlet, then using a small screwdriver prise open the mains selector cover (see illustration on page 6.). Under this cover is a removable carrier that contains the fuse – pull the carrier out to access the fuse inside. Test and replace the fuse with the same type and value if necessary.

### Internal Fuses

The internal power rails are also individually fused. These fuses should only be changed by suitably experienced staff. They are listed below:

#### Fuses (629610X2 Power Regulator Card)

+48V FS1 - 500mA wire ended (SSL part No. 35F5E250)

#### Fuses (629612X1 Main Card)

-18V FS1 - 3 amp wire ended (SSL part No. 35F5E330)

-15V FS2 - 3 amp wire ended (SSL part No. 35F5E330)

+15V FS3 - 3 amp wire ended (SSL part No. 35F5E330)

+18V FS4 - 3 amp wire ended (SSL part No. 35F5E330)

+5V FS5 - 3 amp wire ended (SSL part No. 35F5E330)

### Links

- LK1 Compressor 'Auto Attack'. Normally *not* fitted.  
Fitting across pins 1 & 2 makes the compressor attack time program dependent when 'Linear Release' is selected.  
Fitting across pins 2 & 3 makes the compressor attack time program dependent normal (logarithmic) release is selected.
- LK2 Additional HF roll-off for Mic input transformer. Normally disabled by fitting across pins 1 & 2, fit across pins 2 & 3 to enable.
- LK3 Solder link. Links digital and analogue 0V. Do not remove.
- LK4 Links chassis and analogue 0V. Normally fitted. Remove to increase impedance to 10Ω.

## Appendix B – Connector Details

<b>Input</b>	
Location: Rear Panel	
Conn' Type: XLR Female	
<i>Pin</i>	<i>Description</i>
1	Chassis
2	Audio +ve
3	Audio -ve

<b>Output</b>	
Location: Rear Panel	
Conn' Type: XLR Male	
<i>Pin</i>	<i>Description</i>
1	Chassis
2	Audio +ve
3	Audio -ve

<b>Line In</b>	
Location: Rear Panel	
Conn' Type: TRS Jack Socket	
<i>Pin</i>	<i>Description</i>
Tip	Audio +ve
Ring	Audio -ve
Sleeve	Chassis

<b>Key In</b>	
Location: Rear Panel	
Conn' Type: XLR Female	
<i>Pin</i>	<i>Description</i>
1	Chassis
2	Audio +ve
3	Audio -ve

<b>Link</b>	
Location: Rear Panel	
Conn' Type: TRS Jack Socket	
<i>Pin</i>	<i>Description</i>
Tip	Link Bus *
Ring	Link Bus *
Sleeve	Chassis

\* Tip and Ring are linked to allow use of mono jacks

## Appendix C – Performance Specification

The following pages contain audio performance specification figures for the XLogic E Signature Channel unit. No other Solid State Logic products are covered by this document and the performance of other Solid State Logic products can not be inferred from the data contained herein.

### Measurement Conditions

For each set of figures on the following pages, the specific unit and test setup will be stated at the beginning of that section. Any changes to the specified setup for any particular figure(s) will be detailed beside the figures to which that difference applies.

### Measurement References

Unless otherwise specified the references used in this specification are as follows:

- Reference frequency: 1kHz
- Reference level: 0dBu, where 0dBu  $\approx$  0.775V into any load
- Source impedance of Test Set: 50 $\Omega$
- Input impedance of Test Set: 100k $\Omega$
- All unweighted measurements are specified as 22Hz to 22kHz band limited RMS and are expressed in units of dBu
- All distortion measurements are specified with a 36dB/Octave low pass filter at 80kHz and are expressed as a percentage
- The onset of clipping (for headroom measurements) should be taken as 1% THD
- Unless otherwise quoted all figures have a tolerance of  $\pm 0.5$ dB or 5%

### Microphone Input 1 (Transformer Coupled)

#### Measurement Conditions

Signal applied to Mic Input and measured at Output. Pad switched out and Mic Gain control set to +20dB.

Gain	Continuously variable from +20dB to +70dB Independently switchable 22dB Pad available
Input Impedance	> 1.2k $\Omega$
Output Headroom	> +26dBu at onset of clipping
THD + Noise (-12dBu applied, +36dB gain)	< 0.025% from 20Hz – 20kHz
Frequency Response	$\pm 0.25$ dB from 20Hz to 20kHz
Equivalent Input Noise	< -128dBu at maximum gain (input terminated with 150 $\Omega$ )
Common Mode Rejection (-10dBu applied, +30dB gain)	> 90dB from 50Hz to 1kHz > 80dB at 10kHz

## Microphone Input 2 (Electronically Balanced)

### Measurement Conditions

Signal applied to Mic Input and measured at Output. Pad switched out and Mic Gain control set to +20dB.

Gain	Continuously variable from +20dB to +70dB Independently switchable 22dB Pad available
Input Impedance	> 1.2k $\Omega$
Output Headroom	> +26dBu at onset of clipping
THD + Noise (-12dBu applied, +36dB gain)	Adjustable between < 0.05% and 5% from 20Hz – 20kHz
Frequency Response	$\pm$ 0.3dB from 20Hz to 20kHz
Equivalent Input Noise	< -127dBu at maximum gain (input terminated with 150 $\Omega$ )
Common Mode Rejection (-10dBu applied, +30dB gain)	> 75dB from 50Hz to 1kHz > 65dB at 10kHz

## Line Input

### Measurement Conditions

Signal applied to Line Input and measured at Output. Input Gain set to indent (0dB).

Gain	Continuously variable from -20dB to +20dB
Input Impedance	6k $\Omega$
THD + Noise (+24dBu applied, 0dB gain)	< 0.005% from 20Hz to 20kHz
Frequency Response	$\pm$ 0.25dB from 20Hz to 20kHz
Equivalent Input Noise (Input terminated with 150 $\Omega$ )	< -89dBu

## Channel Output

Output is fully balanced and floating.

Gain	Continuously variable from -20dB to +20dB with indent at 0dB position
Output Headroom	> +26dBu at onset of clipping
Output Impedance	< 80 $\Omega$

## Equaliser

This is a four band equaliser that can be switched between two different sets of curves; one based on SSL's '02' ('Brown Knob') EQ and the other based on the latest version of the classic '242' E Series ('Black Knob') EQ. High and low pass filters are also available.

### HF Band controls:

Frequency	Variable from 1.5kHz to 16kHz
Gain	Variable between $\pm 15$ dB ('02') Variable between $\pm 18$ dB ('242')
'Q' (on 'BELL' setting)	0.8 ('02') 1.3 ('242')

### HMF Band controls:

Frequency	Variable from 600Hz to 7kHz
Gain	Variable between $\pm 15$ dB ('02') Variable between $\pm 18$ dB ('242')
'Q'	Variable from 0.5 to 2.5 ('02') Variable from 0.5 to 4 ('242')

### LMF Band controls:

Frequency	Variable from 200Hz to 2.5kHz
Gain	Variable between $\pm 15$ dB ('02') Variable between $\pm 18$ dB ('242')
'Q'	Variable from 0.5 to 2.5 ('02') Variable from 0.5 to 4 ('242')

### LF Band controls:

Frequency	Variable from 30Hz to 450Hz
Gain	Variable between $\pm 15$ dB ('02') Variable between $\pm 18$ dB ('242')
'Q' (on 'BELL' setting)	0.8 ('02') 1.3 ('242')

### Filter controls:

Low Pass Frequency	3kHz to 16kHz (-3dB Point)
Low Pass Slope	12dB/octave
High Pass Frequency	20Hz to 350Hz (-3dB Point)
High Pass Slope	12dB/octave ('02') 18dB/octave ('242')

### Measurement Conditions

Signal applied to Line Input and measured at Output. EQ switched In. All EQ controls set centre as appropriate.

THD + N	< 0.05% at +20dBu 1kHz
Frequency Response	$\pm 0.25$ dB from 20Hz to 20kHz
Output Headroom	> +26dBu at onset of clipping
Noise	< -73dBu

## Dynamics

The unit contains a complete dynamics section, the functions of which split into two areas; a Compressor/Limiter and an Expander/Gate.

### Compressor/Limiter

#### Controls:

Ratio (slope)	Variable from 1 to infinity (limit)
Threshold	Variable from +10dB to -30dB
Attack Slope	Normally 'Over Easy', switchable to 'Hard Knee'
Attack Time	Normally 30mS per 20dB*, switchable to 3mS ('Fast Att')
Release	Variable from 0.1 to 4 seconds
Release Slope	Normally 'Logarithmic', switchable to 'Linear'

The Compressor/Limiter has two different attack slope modes and two different release slope modes; 'Hard Knee' & 'Over Easy' and 'Logarithmic' & 'Linear' respectively. As their names suggest these modes affect of manner of response to incoming signals. Combining the two modes provides four very different modes of compression and limiting with the 'Hard Knee' and 'Linear' modes giving far more dramatic compression characteristics.

\* When LK1 not fitted (default).

### Expander/Gate

#### Controls:

Range	Variable from 0 to 40dB
Threshold	Variable from -30dB to +10dB
Attack Time	Normally 1.5mS per 40dB, switchable to 100µs
Release Time	Variable from 0.1 to 4 seconds

The side chain signal can be sourced either from the signal feeding the dynamics section or the external Key input. The Filters and/or the EQ can be inserted in the sidechain.

LED meters independently indicate amount of compression and expansion.

### Measurement Conditions

Signal applied to Line Input and measured at Output. All pots anti-clockwise and switches 'out' except for Dynamics 'IN'.

THD + N (+20dBu applied)	< 0.1% at 1kHz
Output Headroom	> +26dBu at onset of clipping
Frequency Response	±0.25dB from 20Hz to 20kHz
Noise	< -73dBu

## Appendix D - Calibration Information

The XLogic E Signature Channel unit is factory calibrated and should only need calibration if a potentiometer or other component has been replaced or if it is suspected that there is a problem with calibration.

In all of the following instructions it is assumed that the lid has been removed and that power has been applied. It is also assumed that unless otherwise specified, all switches are released and all potentiometers are at unity, minimum or indent position as appropriate. The required accuracy for each adjustment will be specified along with the target value.

All level and distortion measurements should be made with audio-band 20Hz to 20kHz filters unless otherwise specified. All adjustments are made on the main (629612) card.

### Line Input

Equipment Required:	Calibrated audio oscillator and audio level meter
Test Signal:	1kHz sinewave @ +6dBu
Input and Output:	Oscillator to Line Input and TP46 on the 629612 card to the audio level meter
Unit Setup:	Set the Line Gain to indent (0dB)

### Level Trim

Adjustment:	1. Adjust VR2 for 0dBu $\pm 0.05$ dB.
-------------	---------------------------------------

### Output Stage

Equipment Required:	Calibrated audio oscillator, audio level meter and dc. volt meter. A 'balance' adaptor (see below) will be required for the output balance adjustment.
Test Signal:	1kHz sinewave @ 0dBu
Input and Output:	Oscillator to Line Input and Output to the audio level meter
Unit Setup:	1. Set both Line Gain and Output Gain to indent (0dB). 2. Press LINE switch IN.

### Unity Gain Trim

Adjustment:	1. Adjust VR28 for 0dBu $\pm 0.05$ dB.
-------------	--

### DC Offset Trim

Adjustment:	1. Turn Oscillator off. 2. Measure on TP54 and adjust VR29 for 0V $\pm 1$ mV. 3. Measure on TP59 and adjust VR30 for 0V $\pm 1$ mV.
-------------	---

### Output Balance

Input and Output:	Signal source as before, connect the Output to the audio level meter via the 'balance' adaptor
Adjustment:	1. Adjust VR31 for minimum level (< 55dB <sub>r</sub> ).

### 'Balance' Adaptor

For the output balance adjustment, a 'balance' adaptor such as that illustrated here will be required. This adaptor consists of a pair of close tolerance resistors in an in-line cable and is used to sum together a balanced output in order to correctly adjust the level balance of the measured output; perfect balance should result in complete signal cancellation.

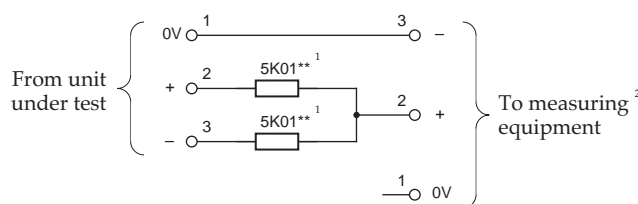

- Note
1. Resistor tolerance should ideally be 0.01%
  2. Absolute level measured will depend upon the input impedance of the measuring equipment.

## **Meter Calibration**

Equipment Required:	Calibrated audio oscillator and audio level meter
Test Signal:	1kHz sinewave @ +24dBu
Input and Output:	Oscillator to Line Input and Output to the audio level meter
Unit Setup:	<ol style="list-style-type: none"><li>1. Set both Line Gain and Output Gain to indent (0dB).</li><li>2. Check for +24dBu output level.</li></ol>
Adjustment:	<ol style="list-style-type: none"><li>1. Adjust VR24 until the '+24' meter LED is just illuminated.</li><li>2. Reduce oscillator level to +18dBu, then +12dBu etc. and check that the correct meter LEDs light. At each point, reduce the level slightly using the Output Gain control and check each LED extinguishes.</li></ol>

## **EQ Alignments**

Equipment Required:	Calibrated audio oscillator and audio level meter
Test Signal:	Sinewave @ 0dBu, frequencies as specified below
Input and Output:	Oscillator to Line Input and Output to the audio level meter
Unit Setup:	<ol style="list-style-type: none"><li>1. Set both Line Gain and Output Gain to indent (0dB). Check that the Filters and Dynamics are switched out.</li><li>2. Switch the EQ in and release all other EQ switches.</li><li>3. Set all of the Q and Frequency controls fully anti-clockwise and all EQ gain controls to their centre indent.</li></ol>

### **LF EQ – Maximum Gain**

Adjustment:	<ol style="list-style-type: none"><li>1. Ensure that the BLK switch is released.</li><li>2. Set LF Gain to maximum and select LF BELL. Set the audio oscillator for 80Hz and adjust LF Frequency to find the maximum level on the audio level meter.</li><li>3. Adjust VR4 for +15dBu <math>\pm</math>0.25dB.</li><li>4. Switch BLK in and re-adjust LF Frequency for maximum level.</li><li>5. Adjust VR6 for +18dBu <math>\pm</math>0.25dB.</li><li>6. Reset LF Gain to its centre indent position, release the BLK switch and de-select LF BELL. Re-check the audio level meter for 0dBu.</li></ol>
-------------	--

### **LMF EQ – Maximum Gain**

Adjustment:	<ol style="list-style-type: none"><li>1. Ensure that the BLK switch is released.</li><li>2. Set LMF Gain to maximum and LMF Q fully anti-clockwise. Set the audio oscillator for 1kHz and adjust LMF Frequency to find the maximum level on the audio level meter.</li><li>3. Adjust VR9 for +15dBu <math>\pm</math>0.25dB.</li><li>4. Switch BLK in and re-adjust LMF Frequency for maximum level.</li><li>5. Adjust VR12 for +18dBu <math>\pm</math>0.25dB.</li><li>6. Reset LMF Gain to its centre indent position and release the BLK switch. Re-check the audio level meter for 0dBu.</li></ol>
-------------	--

### **HMF EQ – Maximum Gain**

Adjustment:	<ol style="list-style-type: none"><li>1. Ensure that the BLK switch is released.</li><li>2. Set HMF Gain to maximum and HMF Q fully anti-clockwise. Set the audio oscillator for 3kHz and adjust HMF Frequency to find the maximum level on the audio level meter.</li><li>3. Adjust VR14 for +15dBu <math>\pm</math>0.25dB.</li></ol>
-------------	--

4. Switch BLK in and re-adjust HMF Frequency for maximum level.
5. Adjust VR16 for +18dBu  $\pm 0.25$ dB.
6. Reset HMF Gain to its centre indent position and release the BLK switch. Re-check the audio level meter for 0dBu.

### HF EQ – Maximum Gain

Adjustment:

1. Ensure that the BLK switch is released.
2. Set HF Gain to maximum and select HF BELL. Set the audio oscillator for 12kHz and adjust HF Frequency to find the maximum level on the audio level meter.
3. Adjust VR19 for +15dBu  $\pm 0.25$ dB.
4. Switch BLK in and re-adjust HF Frequency for maximum level.
5. Adjust VR21 for +18dBu  $\pm 0.25$ dB.
6. Reset HF Gain to its centre indent position, de-select HF BELL and release the BLK switch. Re-check the audio level meter for 0dBu.

### Dynamics Adjustments

If the dynamics circuitry requires adjustment the following procedure should be followed in the order shown, in its entirety. All presets are on the 629612 card.

Equipment Required:	Calibrated audio oscillator, audio level meter and a (digital) dc. volt meter
Test Signal:	1kHz sinewave unless specified otherwise, level as specified
Input and Output:	Oscillator to Line Input, Output to the audio level meter.
Unit Setup:	Switch the dynamics IN and the EQ and Filter sections OUT, set all of the dynamics controls anti-clockwise and release all switches

### Unity Gain

Adjustment:

1. Set the oscillator for 0dBu.
2. Adjust VR26 for 0dBu  $\pm 0.05$ dB.

### RMS-to-DC Converter Gain

Adjustment:

1. Set the oscillator for -3.2dBu.
2. Measure on TP30 and adjust VR27 for -1.7V  $\pm 50$ mV.

### RMS-to-DC Converter DC Offset

Adjustment:

1. Set the oscillator for 0dBu.
2. Measure on TP22 and adjust VR25 for -3.0V  $\pm 50$ mV.

### Gate Threshold

Adjustment:

1. Set the oscillator for +14dBu.
2. Adjust VR25 until the gate just opens.
3. Check this adjustment by changing the oscillator level a little. Re-adjust VR25 if necessary so that the gate just opens when a +14dBu signal @ 1kHz is applied.

## Appendix E – Physical specification \*

Depth:	363mm / 14.3 inches	<i>casing and heatsink, excluding front panel knob(s) and rear connectors</i>
	425mm / 16.75 inches	<i>including connectors, excluding front panel knob(s)</i>
Height:	44.5mm / 1.75 inches (1 RU)	
Width:	444mm / 17.5 inches	<i>casing only</i>
	481mm / 19 inches	<i>including rack ears</i>
Weight:	4.0kg / 9 pounds	
Power:	35 Watts / 47 VA	
Boxed size:	520mm x 520mm x 182mm / 20.5" x 20.5" x 7.2"	
Boxed weight:	6.3kg / 14 pounds	

\* All values are approximate

## Appendix F – Environmental Specification

Temperature	Operating:	5 to 30 Deg. C
	Non-operating:	-20 to 50 Deg. C
	Max. gradient:	15 Deg. C/Hour
Relative Humidity	Operating:	20 to 80 %
	Non-operating:	5 to 90 %
	Max. wet bulb:	29 Deg. C (non-condensing)
Vibration	Operating:	< 0.2 G (3 - 100Hz)
	Non-operating, power off:	< 0.4 G (3 - 100Hz)
Shock	Operating:	< 2 G (10mSec. Max.)
	Non-operating:	< 10 G (10mSec. Max.)
Altitude	Operating:	0 to 3000m (above sea level)
	Non-operating:	0 to 12000m

## **Notes**

