

Duende V3

User's Guide

Duende V3. This is SSL.

Solid State Logic
S O U N D | | V I S I O N

Contents

1. Introduction	1	6. EQ & Dynamics Channel Strip	11
2. Duende V3 System Requirements	2	6.1 Introduction	11
3. Duende Classice & Mini Software & Hardware Installation	3	6.2 Input Section	12
4. Duende PCI-e Software & Hardware Installation	4	6.3 Filter Section	12
5. Operational Overview	5	6.4 Equaliser Section	13
5.1 Duende Preferences/Control Panel	6	6.5 Dynamics Section	16
5.2 Upgrade Options	7	6.6 Advanced Signal Routing Options	20
5.3. Resource Management	8	7. Duende Support	21
5.4 Guidelines for Plug-in Delay Compensation	8		



1. Introduction

Congratulations on your purchase of Duende V3 – the SSL processing solution for your audio workstation.

In 2005, we decided to embark on a technology project to figure out how we could take the processing power of a console and squeeze it into a 1U rack, so we could serve up the SSL sound to home and project studio owners who don't have the budget (*or the floor space!*) required to install a large-format console.

Drawing on our unique understanding of audio processing and years of DSP know-how, our team of engineers set about creating the SSL processing solution for your DAW environment. We knew we needed serious DSP horsepower to accommodate our powerful algorithms, and we knew it had to come in a package that could integrate seamlessly with the most popular workstations... And so Duende was born.

Duende V3's new Hybrid Core Processing engine combines all of the advantages of dedicated DSP with your computers CPU processing power. This brings with it significant advantages, including higher plug-in counts, lower latency and the opportunity for us to utilise more complex audio algorithms.

Duende is currently available in two form factors: Duende Mini and Duende PCIe. The discontinued Duende Classic is still supported by V3 software. Duende offers complete integration into the most popular workstation environments with one simple FireWire or PCIe connection. The different processing blocks appear as VST/AU/RTAS plug-ins – and include an authentic SSL channel strip with filters, E and G series EQ and dynamics processing.

We hope you will enjoy mixing your music with Duende.

For product news and software updates please register at www.solidstatellogic.com/duende

2. Duende V3 System Requirements

Windows/PC

- Intel Core2 or equivalent, 2GHz or higher
- 2GB RAM
- Windows XP Service Pack 2 or higher or Windows Vista – only 32 bit versions are supported
- 80MB of free hard disk space
- Approved RTAS or VST compatible host application
- Duende Classic or Mini: one available Firewire port (1394A/400Mbit) – for details on compatible firewire cards please visit: www.solidstatelogic.com/duende
- Duende PCIe: 1x or higher PCIe slot
- 17" or larger colour monitor with screen resolution of 1024 x 768 or higher recommended
- Internet Connection (*for product registration and to download software updates*)

Apple Macintosh

- Intel Mac 1.8GHz or higher
- 2GB RAM
- Mac OS X 10.5.6 or higher
- 60MB of free hard disk space
- Audio Units, RTAS or VST compatible host application
- Duende Classic or Mini: one available Firewire port (1394A/400Mbit) – for details on compatible firewire cards please visit: www.solidstatelogic.com/duende
- Duende PCIe: 1x or higher PCIe slot
- 17" or larger colour monitor with screen resolution of 1024 x 768 or higher recommended
- Internet Connection (*for product registration and to download software updates*)

3. Duende Classice & Mini Software & Hardware Installation

PC

1. Insert the Duende installation CD in to your CD drive
2. Navigate to your CD drive
3. Launch the Duende installer by double clicking the Duende installer icon
4. Follow the installation instructions on the screen
5. Connect IEEE 1394 Firewire Cable
6. Connect Power to Duende (*if required*)
7. Switch Duende On
8. After the Duende installer has installed all of the required software on your computer, click 'Finish' to quit the installer

Mac

1. Ensure that both Duende and your computer are powered down
2. Connect IEEE1394/Firewire
3. Connect Power to Duende (if required)
4. Switch Computer On
5. Switch Duende On
6. Insert the Duende installation CD in to your CD drive
7. Click the Duende icon to view the CD content
8. Launch the Duende installer by double clicking the Duende Installer icon
9. Follow the installation instructions on screen
10. After the Duende installer has installed all of the required software on your computer, click 'Finish Up' to quit the installer

4. Duende PCI-e Software & Hardware Installation

PC

1. Power down the computer and remove the power lead
2. Remove the cover(s) to gain access to the PCIe sockets
3. Locate a free PCIe socket and ensure that the rear panel blanking plate is removed
4. Plug your Duende PCIe card into the PCIe socket and secure the mounting bracket to the computer case
5. Re-fit the cover(s) to the computer and re-connect the power lead
6. Switch the computer on. The **Add New Hardware Wizard** should appear. Ignore this; do not press **Next** and do not press **Cancel**
7. Insert the Duende Installation CD in your CD/DVD drive
8. Double click the CD icon to view the CD content. If Autorun is enabled this will happen automatically
9. Double click the SSL Duende Setup icon
10. Follow the on-screen instructions, making sure to attend to the **Add Hardware Wizard** when prompted

Mac

1. Power down the computer and remove the power lead
2. Remove the cover(s) to gain access to the PCIe sockets
3. Locate a free PCIe socket and ensure that the rear panel blanking plate is removed
4. Plug your Duende PCIe card into the PCIe socket and secure the mounting bracket to the computer case
5. Re-fit the cover(s) to the computer and re-connect the power lead
6. Switch the computer on
7. Insert the Duende installation CD in your CD/DVD drive
8. Double click the CD icon to view the CD content
9. Launch the Duende Installer by double clicking the Duende Installer icon
10. Follow the on-screen instructions

5. Operational Overview

Once your Duende hardware and software has been properly installed, Duende plug-ins are accessed and used just like any host-based plug-in. You can run Duende plug-ins simultaneously with your other plug-ins in any combination. Below are the locations of Duende plug-ins in common audio applications:

Logic: Audio Units > SSL

Cubase/Nuendo: Solid State Logic

Pro Tools: Wrapped Plug-ins

Duende plug-in parameters are changed by dragging, rotating or clicking knobs and buttons, whose behaviour varies slightly depending on which software is being used to host the plug-ins. Generally the further away the mouse pointer is from the knob, the more resolution is available for parameter adjustment.

When the mouse cursor is hovered over a knob its value is displayed in the appropriate units. At any point you can see exactly what value a knob has without touching it. If you have a mouse with a scroll wheel, the wheel can also be used to change the knob position.

Windows

To reset a knob to its default value hold 'Ctrl + click' on that knob.

For very fine adjustment, hold 'Shift' whilst dragging.

OS X

To reset a knob to its default value hold 'Command + click' on that knob.

For very fine adjustment, hold 'Shift' whilst dragging.

Every Duende plug-in parameter can be automated so long as parameter automation is supported by the host application. The method for recording and editing automation varies from host to host. For specific instructions on using automation with the host consult the host application documentation.

5.1 Duende Preferences/Control Panel

The Duende Preferences/Control Panel shows information about your Duende(s) such as serial number (*Authentication ID*), firmware version and driver version. It also displays resource information and allows you to easily see how many processing units are in use on each Duende.

Windows

The panel can be found in 'Start Menu > Programs > Solid State Logic > Duende' or in the Windows control panel.

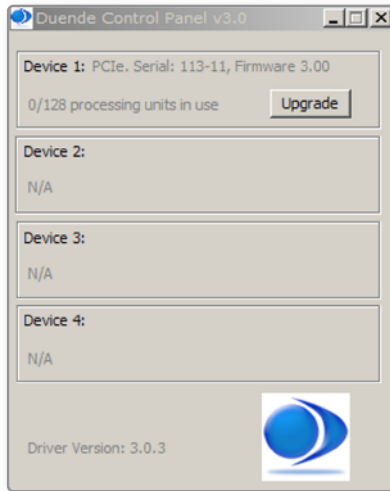

OS X

The panel can be found by navigating to 'Apple > System Preferences > SSL Duende'.

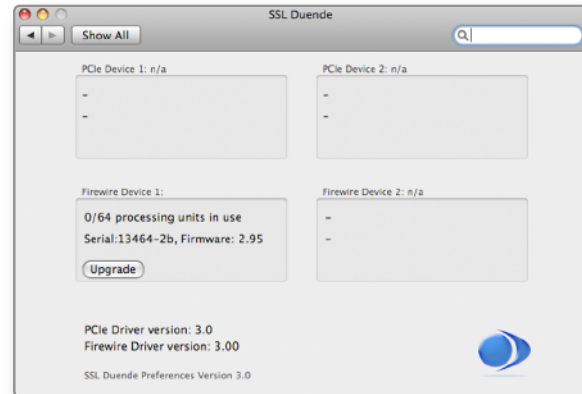

5.2 Upgrade Options

Duende V3 software features various upgrade options which are either bundled with the hardware or purchased separately from the SSL webshop: www.solidstatelogic.com/store The upgrades include various plug-in licenses and channel count upgrades.

Upgrade options are accessed from the Preferences/Control Panel by pressing the 'Upgrade' button. Here you will see a list of plug-in and channel count options, each displaying their status. To unlock a plug-in or enable a channel count upgrade, press the appropriate 'Unlock' button and enter the unlock code. The option will then be permanently enabled in the Duende hardware so it will work on any computer system on which the software is installed.

Windows

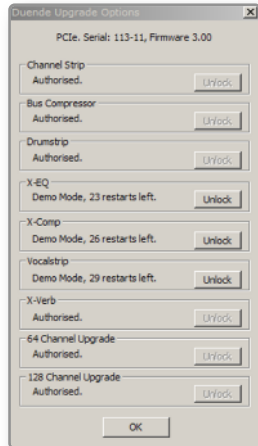

OS X

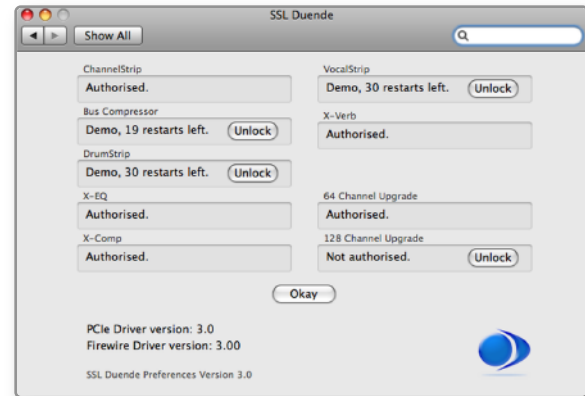

5.3. Resource Management

Duende V3 software uses Hybrid Core Processing technology which means the total quantity of plug-ins you are able to run is based on both the amount and type of Duende hardware along with the power of the host CPU. The total quantity of Duende plug-ins that can be run on any one system is dependent on both these factors.

Duende Hardware Limitations

Each Duende plug-in supports up to 64bit 96kHz operation and Duende V3 features a unit based processing resource system. Each Duende can have up to 128 processing units, where 1 mono Channel Strip at 44.1/48kHz occupies 1 processing unit. A stereo Channel Strip takes 2 processing units and these figures are doubled for 88.2 or 96kHz operation.

For example, host computer power permitting, you would be able to run 32 Stereo Channels and 32 Stereo Bus Compressors at 44.1/48kHz, or 16 of each at 88.2/96kHz on 1 fully expanded 128 unit Duende.

Host Computer Limitations

The amount of host CPU power used by Duende plug-ins depends on a number of factors:

- Processing power of the host computer
- Type of Duende plug-in loaded
- Hardware buffer size

As Duende processing unit availability is based partly on sample rate, so is the host CPU usage – higher sample rates will generally use twice as much host CPU resources.

5.4 Guidelines for Plug-in Delay Compensation

Duende V3 plug-ins exhibit far lower latencies values than their predecessors. The latency of a Duende V3 plug-in is only limited by the amount of look ahead delay, if any, that each particular plug-in features. For example, the Bus Compressor plug-in has a look ahead of 4 samples, where as the Channel Strip does not have any.

Duende V3 plug-ins are useable on ‘live’ inputs, as the latency they introduce is small. This means you could realistically monitor a live signal through your DAW with a Duende Channel plug-in inserted on the recording channel, providing the host buffer size is kept low.

On playback most host applications automatically compensate for this latency by simply turning on the Plug-in Delay Compensation (*PDC*) or similar, usually found in the application preferences. Some hosts even provide full plug-in delay compensation throughout the entire signal path, including sends, groups, and buses. The location of the settings for the PDC option within some common host applications is as follows:

PDC	No PDC
Steinberg Cubase 4	Final Cut Pro
Steinberg Cubase SX 2 & 3	Soundtracks Pro
Steinberg Nuendo 2, 3 & 4	Garageband
Logic Pro 7.1 or higher	Pro Tools LE and
Digital Performer 4.5 & higher	M-Powered
Pro Tools HD 7 or higher	
Ableton Live 5 or higher	
Cakewalk Sonar 5 or higher	

Cubase + Nuendo

Always on unless the ‘Constrain Delay Compensation’ feature is used to disable delay compensation on individual plug-ins: ‘Devices Menu > Plug-in Information > Use Delay Compensation’

Logic

‘Preferences > Audio > General’

Digital Performer

‘Setup menu > Configure Audio System > Configure Studio Settings...’

Ableton Live!

‘Options > Delay Compensation’

Important: Delay compensation is fully automatic and requires no user intervention when Duende plug-ins are used in hosts that support full Plug-in Delay Compensation.

Depending on the host application implementation, the delay compensation feature may not provide automatic compensation when Duende plug-ins are inserted on sends, groups, or buses. In this situation, the solution is to manually compensate for the plug-ins.

These explanations of delay compensation apply primarily to playback only.

Compensating for latency in Pro Tools LE and M-Powered

Because Pro Tools LE and M-Powered do not feature PDC it must be done manually when plug-ins are used. Due to the Hybrid Core Processing technology of Duende V3, a small latency is introduced which will delay any audio track, aux input, master fader or instrument track by a specific amount. Tracks that use no Duende plug-ins or fewer than the track with the most Duende plug-ins will need to be delayed so that all tracks are in time. Because this latency is reported by Pro Tools it is easily compensated for.

The track with the most Duende plug-ins will introduce the most latency, those with 1 or 2 plug-ins will introduce less and those with no Duende plug-ins will introduce no latency (*providing other plug-ins that introduce latency are not used*).

To find out the latency introduced on a particular track by Duende plug-ins, go to the channel in the mixer and ‘Command/Ctrl+Click’ twice in the green text below the fader (*normally showing vol*). The value shown (*dly*) is the latency introduced on that track in samples.

Now load the ‘Digidesign Time Adjuster Long’ plug-in on, for example, a track with no Duende plug-ins. Double click on the delay box and type in the latency value of the track that has the most Duende plug-ins. The track with the most Duende plug-ins and the track with none will now be perfectly in sync on playback. Any tracks that have a smaller latency than the maximum must also be delayed but by a smaller amount (*ie. tracks with 1 Duende plug-in where the maximum has 3*).

The delay value for these will be maximum latency minus the latency reported by that track. Pro Tools HD users have the luxury of being able to use Automatic Delay Compensation, as opposed to the manual method required in Pro Tools LE and M-Powered.

6. EQ & Dynamics Channel Strip

6.1 Introduction

The Duende EQ and Dynamics Channel Strip plug-in is based on the EQ and compressor sections of the XL 9000 K Series console. SSL were the first mixing console manufacturer to feature dynamics and EQ on every channel on an in-line console with the SL 4000 B Series in 1977. The plug-in includes separate high and low pass filters, a four band parametric equalizer, an independent compressor/limiter and gate/expander as well as input and output gain adjustment knobs and a phase invert button. Let's have a closer look at each section in detail.



6.2 Input Section

Gain: Controls the level of the incoming audio signal.

Ø (Phase Reverse): Reverses the phase of the incoming input signal.

Also present in the input section is a 6 segment meter.

6.3 Filter Section

The Filter section includes a 12dB/Octave low pass filter and an 18dB/Octave high pass filter. The low pass filter operates from 3kHz to 22kHz and the high pass filter operates from 20Hz to 500Hz. In addition, each filter has an OUT position which bypasses the filter. There are three positions where the Filter section can be placed: after the equalizer, before the equalizer or in the sidechain of the dynamics section. When no buttons in the Filter section are pressed, the filters are placed after the Equalizer section. With the INPUT button pressed, the filters are placed before the Equalizer section. When the DYN S/C button is pressed, the filters are switched into the sidechain of the Dynamics section. The term/process 'sidechain' will be discussed in greater detail in the overview of the Dynamics section.

Using Filters

DYN SC: The Filters are switched into the sidechain of the Dynamics section. The Equaliser can be switched into the sidechain independently. Note that DYN S/C overrides the INPUT function (see below).

INPUT: Moves the Filters to place them immediately after the Channel Input section. This allows the Filters to be used to clean up signals before compressing them. Selecting Dynamics 'PRE EQ' will allow the compressed signal to be EQ'd.

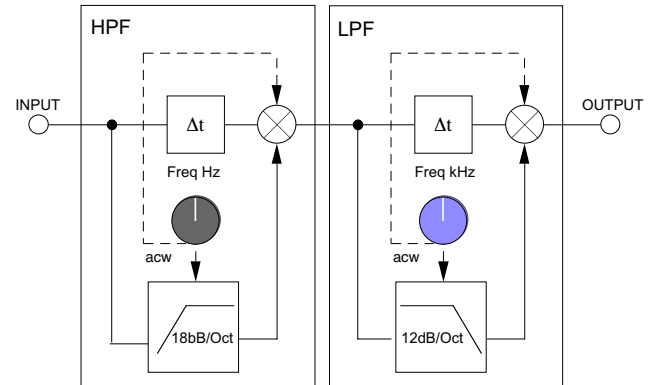

6.4 Equaliser Section

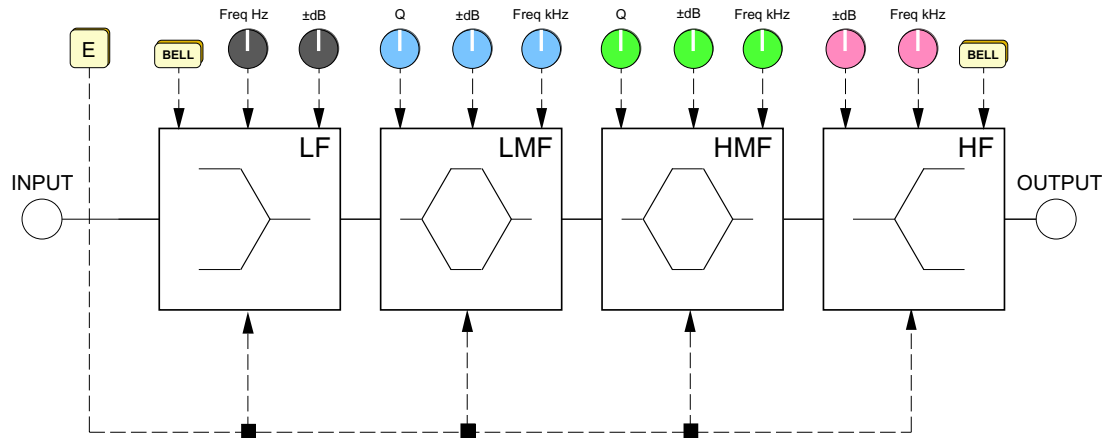

Operation

The equalizer included with the Duende EQ and Dynamics Channel Strip plug-in is a four band parametric EQ with filters. Based on the XL 9000 K Series EQ circuit, this plug-in includes two distinct EQ curves, one based on the SSL G Series EQ and another based on the latest version of SSL's classic E Series EQ.

The G series EQ bandwidth varies with applied gain and so increases the selectivity of the EQ. This EQ type generally works best at moderate settings, particularly on instruments or vocals as a gentle, corrective EQ. The E Series EQ is the 'Black Knob' circuit, which has a constant-bandwidth at all gains. This means that it can be particularly useful for 'surgery EQ tasks' as it offers relatively narrow Q at relatively low gains.

Note – at full boost or cut both curves are identical. The plug-in includes high and low frequency shelving equalizers (which can be switched to peaking curves via the BELL button) and two overlapping equalizers with adjustable Q.

- **LF:** Operates over a frequency range of 40Hz to 600Hz and is capable of up to 16.5dB of cut or boost. Selecting BELL in this mode switches the equaliser to a peaking curve.
- **LMF:** Operates over a frequency range of 200Hz to 2kHz and is capable of ± 20 dB of gain with a continuously variable Q from 0.5 to 2.5.
- **HMF:** Operates over a frequency range of 600Hz to 7kHz and is capable of ± 20 dB of gain with a continuously variable Q from 0.5 to 2.5.
- **HF:** Operates over a frequency range of 1.5kHz to 22kHz and is capable of up to ± 20 dB of cut or boost. Selecting BELL in this mode switches the equaliser to a peaking curve.

By default, the Duende EQ is set to the G Series EQ curve. The G Series shelving curves have a degree of overshoot/undershoot (*depending on whether you are boosting or cutting*) below the selected HF frequency or above the selected LF frequency. At any Q setting, the bandwidth of the HMF and LMF sections varies with gain, whereby an increase in boost or cut increases the selectivity of the EQ. This type of EQ can sound effective when used at moderate settings; the gentle Q curve lends itself to the application of overall EQ on combined sources and subtle corrective adjustments to instruments and vocals.

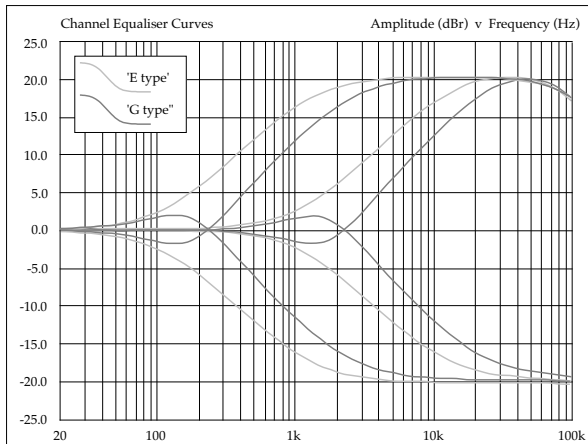

When the EQ is switched to 'E' operation (*by pressing the "E" button in the GUI*), the bandwidth of the HMF and LMF sections remains constant at all gains, so at lower gains the EQ curves are comparatively narrower for a given Q setting. This is particularly useful for drums, since relatively high Q is available at low gain settings. However, it is not so suitable for overall EQ or subtle corrections, as you need to adjust the Q to maintain the same effect when the gain is changed the 'E' curve could be described as more aggressive.

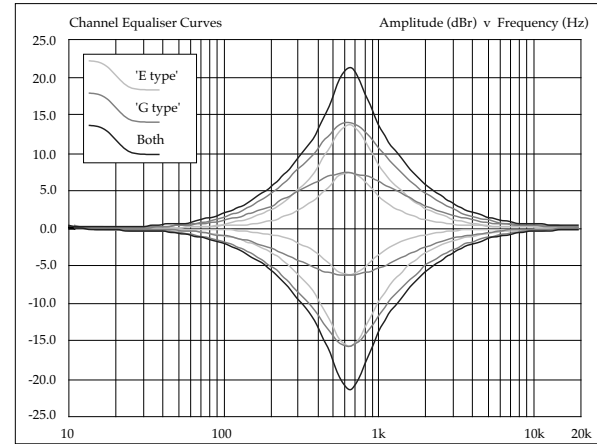

There are three buttons associated with this section of the plug-in.

- **EQ IN:** Switches the EQ section into circuit.
- **E:** Switches the EQ from 'G' operation to 'E' operation – see above.
- **DYN SC:** Switches the EQ section into the sidechain of the Dynamics section. The Filter Section can be switched independently of the EQ section. If both Filter and EQ sections are assigned to the dynamic sidechain the EQ section precedes the Filter.

Compressor/Limiter Introduction

The Channel Compressor/Limiter section has a number of key features including a variable compression ratio from 1:1 to ∞ :1, a variable threshold from -20dB to $+10\text{dB}$, auto sensing attack time (*or selectable 1ms attack time*), and a variable release from 0.1 to 4 seconds.

The Compressor/Limiter has two modes of signal detection, Peak and RMS. As their names suggest these modes of detection either act on peaks of the incoming signals or on their RMS or average levels. This gives two very different modes of compression and limiting with Peak Mode giving far more dramatic compression characteristics.

Detailed Parameter Description

RATIO: When turned to 1:1, the Compressor/Limiter section is inactive. Turning the control clockwise increases the compression ratio to give a true limiter at the fully clockwise position. The compressor normally has an 'over-easy' characteristic. Selecting PK changes this to peak sensing, and replaces the 'over-easy' characteristic with a hard knee, providing an alternative for some instruments.

THRESHOLD: Whenever a signal exceeds the level set by this control, the compressor will start to act at the ratio set by the RATIO control. This control also provides automatic make-up gain, so as you lower the threshold and introduce more compression, the output level is increased, maintaining a steady output level regardless of the amount of compression.

RELEASE: Sets the time constant (*speed*) with which the compressor returns to normal gain settings once the signal has passed its maximum.

FAST ATT: Provides a fast attack time (*3ms for 20dB gain reduction*). When off the attack time is program dependent (*3ms to 30ms*). The yellow and red indicators, on the bottom of the compression meter, indicate the amount of gain reduction (*compression*).

Expander/Gate Introduction

The Expander/Gate section contains a number of useful features including a variable range from 0 to 40dB, a variable threshold from -30dB to +10dB, a fixed attack time (*switchable to Fast Attack of 100µs*), a variable hold time from 0 to 4 seconds and a variable release time from 0.1 to 4 seconds.

The sidechain signal is sourced from the signal feeding the Dynamics section and the Filters and/or Equaliser can be inserted in this sidechain. The green indicators on the Gate meter show the amount of gain reduction on the Expander/Gate.

By default, the Expander/Gate section functions as an ∞:1 gate. When the EXP button is pressed, the section becomes a 2:1 expander.

Detailed Parameter Description

RANGE: Determines the depth of gating or expansion. When turned fully anticlockwise (*Range = 0*), this section is inactive. When turned fully clockwise, a range of 40dB can be obtained.

THRESHOLD: A variable hysteresis is incorporated in the threshold circuitry. For any given 'open' setting, the Expander/Gate will have a lower 'close' threshold. The hysteresis value is increased as the threshold is lowered. This is very useful in music recording as it allows instruments to decay below the open threshold before gating or expansion takes place.

RELEASE: This determines the time constant (*speed*), variable from 0.1 to 4 seconds, at which the Expander/Gate reduces the signal level once it has passed below the threshold. Note that this control interacts with the RANGE control.

FAST ATT: Provides a fast attack time (*100µs per 40db*). When off, a controlled linear attack time of 1.5ms per 40dB is selected. The attack time is the time taken for the Expander/Gate to 'recover' once the signal level is above the threshold. When gating signals with a steep rising edge, such as drums, a slow attack may effectively mask the initial 'Thwack', so you should be aware of this when selecting the appropriate attack time.

HOLD: Determines the time after the signal has decayed below the threshold before the gate closes. Variable from 0 to 4 seconds. (*Note that when the Dynamics section is not in circuit, the sidechain input is also bypassed.*)

Output Section

The Output section consists of a 20dB output gain control, and a 6-segment meter.

S/C LISTEN: Pressing the S/C LISTEN switch routes the sidechain directly to the output, so you can monitor the sidechain signal.

BYPASS ALL: Engaging this button will bypass all channel processing whilst still routing the signal through Duende. This avoids the time shift which occurs when a 'hard' bypass is done using the default DAW control, allowing for easier A/B comparison between processed and unprocessed signals.

6.6 Advanced Signal Routing Options

Channel Processing Order

There are two switches that control the order of the signal processing elements. These are the INPUT switch in the Filter section and the PRE EQ switch in the Dynamics section. The table below shows the effect of these:

Switch 1	Switch 2	Processing Order		
		Equaliser	Filters	Dynamics
Filters to INPUT		Filters	Equaliser	Dynamics
Dynamics PRE EQ		Dynamics	Equaliser	Filters
Filters to INPUT	Dynamics PRE EQ	Filters	Dynamics	Equaliser

Side Chain Processing Order

The EQ and filter sections can be assigned to the Dynamics sidechain using the DYN S/C switches in the respective sections. The table below shows the sidechain source and processing for the various combinations of these:

Switch 1	Switch 2	SC Source	Sidechain Processing order	
		Dynamics Input		
EQ to Dyn S/C		Dynamics Input	Equaliser	
Filters to Dyn S/C		Dynamics Input	Filters	
EQ to Dyn S/C	Filters to Dyn S/C	Dynamics Input	Equaliser	Filters

7. Duende Support

Support FAQs

To access the latest support information on Duende, please visit our online support site:

www.solidstatelogic.com/support

The information there is kept up to date by our support staff to make sure all information is accurate. All information is available to you 24/7. If you can't find your answer or a solution to your issue, you can submit a question via the site to our support staff for resolution.



Solid State Logic
SOUND || VISION

Support

FAQs, documentation and other useful utilities

A great product is only the start of what sets SSL equipment apart. We believe that the world's best products demand the best support. To provide this, SSL has a network of sales and service centres throughout the world, including its subsidiaries in New York, Los Angeles, Paris and Milan. Through these offices, and appointed distributors in other countries, a full program of backup and technical support is guaranteed. Underpinning all this local expertise is the global support available from SSL's service centre at the company headquarters near Oxford, England.

Console Resources	Duende	Audio I/O	Workstation Products	Analogue Outboard
				
Duality AWS 900+ C100 HD C300 HD C300 HD SL 9000 K	Duende Classic Duende Mini Duende PCIe Plug-ins	Alpha-Link Range Delta-Link MADI-HD MadiXtreme MADI Opti-Coax	Pre-Convert Mixpander X-15M Plug-in LMC-1 Plug-in Soundscape	X-Rack G Series Bus Comp E-Signature Channel Super-Resampler Ch. Multichannel Comp Alpha Channel

Solid State Logic
SOUND || VISION

Solid State Logic

S O U N D | | V I S I O N

Visit SSL at: www.solidstatelogic.com

82S6MCo60B

© Solid State Logic

All Rights reserved under International and Pan-American Copyright Conventions

Duende is a trademark of Solid State Logic

All other product names and trademarks are the property of their respective owners and are hereby acknowledged

No part of this publication may be reproduced in any form or by any means, whether mechanical or electronic,
without the written permission of Solid State Logic, Oxford, OX5 1RU, England

As research and development is a continual process, Solid State Logic reserves the right to change the features and specifications described herein without notice or obligation.

Solid State Logic cannot be held responsible for any loss or damage arising directly or indirectly from any error or omission in this manual.

E&OE

Solid State Logic
S O U N D | | V I S I O N